

Easy-to-Use Windows® Based Interface

The Windows® toolbars and drop-down menus make it easy to set parameters for calibration, method development, and data processing. The PC interface also includes advanced diagnostics, extended archiving, and flexible reporting capabilities. A thorough on-board manual, including illustrations and screen captures, quickly gives you the direction you need without having to leave your instrument.

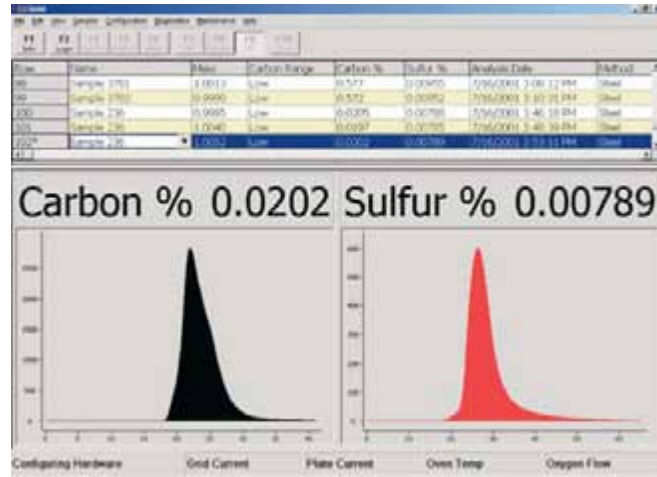

Standard Interface incorporates data spreadsheet and sample plots

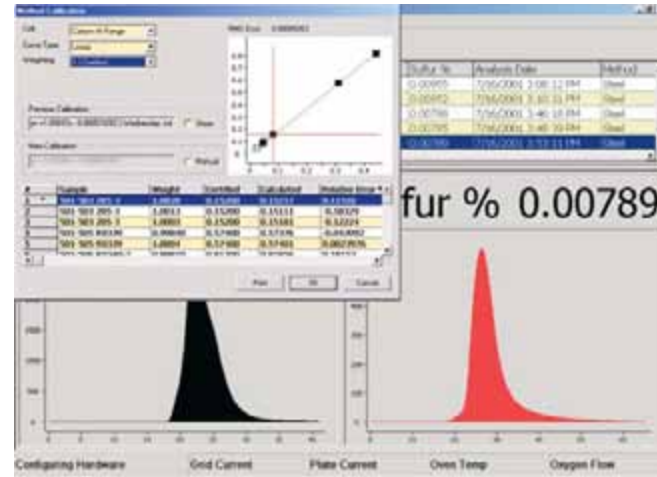

Calibration Screen detailing linear, multi-point calibration

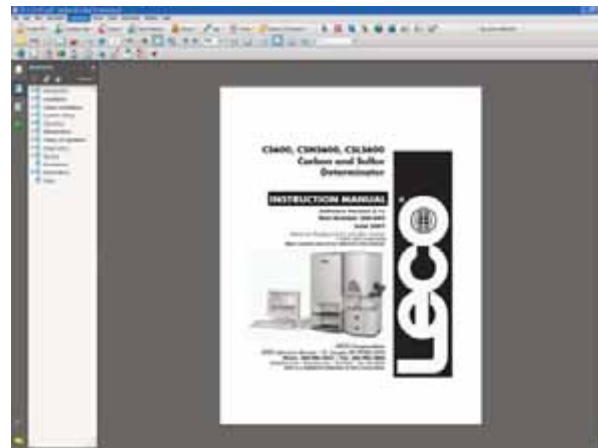

On-Board Manual

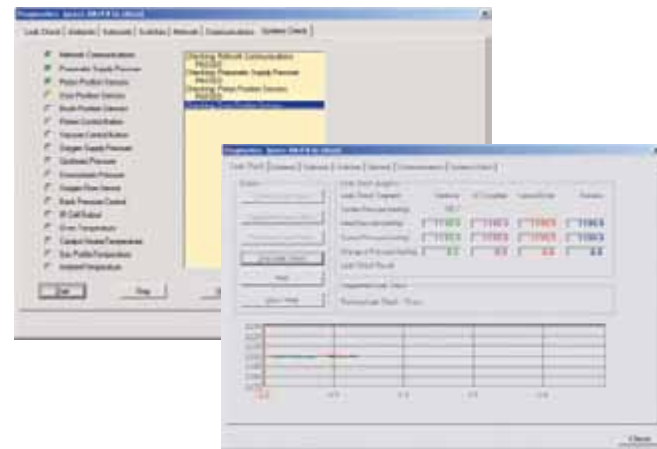

Real-Time Diagnostics

Available Models

CS600 Carbon/Sulfur Determinator Specification Sheet 209-120-001	CSLS600 Carbon/Low Sulfur Determinator Specification Sheet 209-120-004	SDR600 Sulfur Dual-Range Determinator Specification Sheet 209-120-007
C600 Carbon Determinator Specification Sheet 209-120-002	CSHS600 Carbon/High Sulfur Determinator Specification Sheet 209-120-005	WC600 Carbon Determinator Specification Sheet 209-120-008
S600 Sulfur Determinator Specification Sheet 209-120-003	SHS600 High Sulfur Determinator Specification Sheet 209-120-006	CHSDR600 High Carbon Dual-Range Determinator Specification Sheet 209-120-009

Options

Sample Autoloader	Printer	Interfaced Balance Kit	SmartLine® Remote Diagnostics
-------------------	---------	------------------------	-------------------------------

3000 Lakeview Avenue • St. Joseph, MI 49085 • Phone: 800-292-6141 • Fax: 269-982-8977
info@leco.com • www.leco.com • ISO-9001:2000 • No. FM 24045 • LECO is a registered trademark of LECO Corporation.

LECO Corporation
Delivering the Right Results



LECO®
CS600 Carbon/Sulfur Series

CS600 Carbon/Sulfur Series

Advanced solutions for your most demanding carbon/sulfur requirements.

Since 1936 LECO has proven itself as the world leader in providing high-performance Carbon/Sulfur analysis instrumentation. Our determinators are designed to meet and exceed the ever-increasing requirements of R & D, production control, and quality assurance.

Today this commitment continues with the CS600 Series. By combining LECO's proven combustion technology with state-of-the-art advancements, you are able to analyze a wider variety of metals and inorganic materials with greater accuracy, precision, and ease-of-use.

LECO introduces combustion-based "Rapid" Volumetric Carbon Determinator suitable for production control



Introduction of simultaneous Carbon/Sulfur Determinator (featuring IR Detection) with improved speed and accuracy



Implementation of sub-ppm detection limits, a wide dynamic range, and advanced database capabilities

Innovative communications hardware and software deliver optimum performance



Reengineered Reagent Train
(safety-protected behind cabinet shield)
Promotes increased reagent life while improving analyte and carrier gas transfer



Programmable Autocleaner
Provides dual-zone cleaning with dust removal for a cleaner sample environment

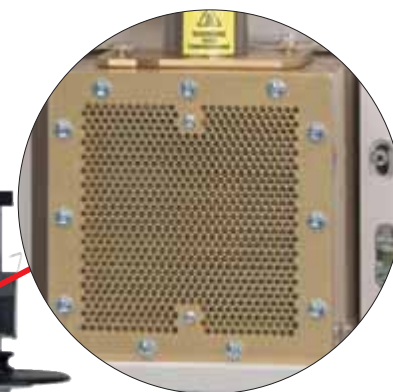

High-Frequency Induction Furnace
Offers programmable power levels

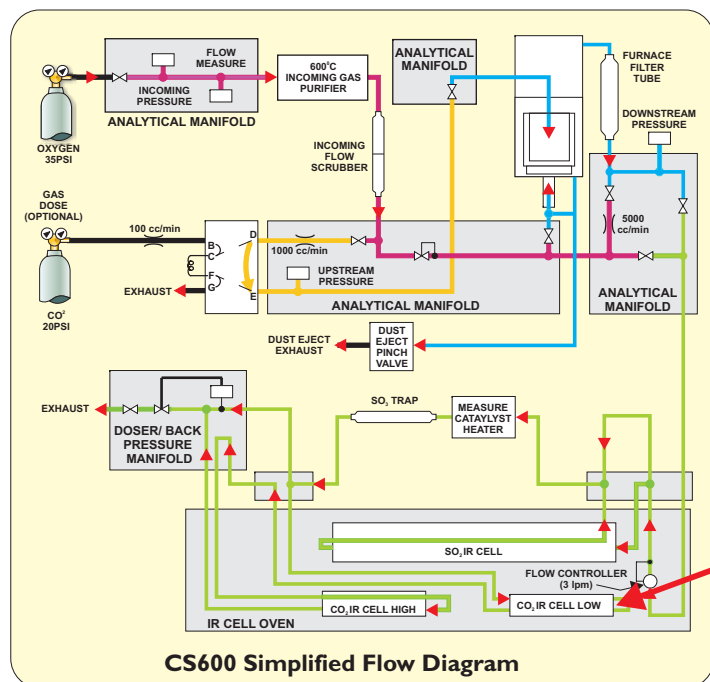

- Segmented leak check
- Optimized stability—requires less calibration
- Auto high/low analyte detection
- Exclusive ECLIPSE network protocol



Patented Solid State Infrared Detection
Features no moving parts or manual adjustments, as well as the ability to upgrade from dedicated C or S to simultaneous C/S determination

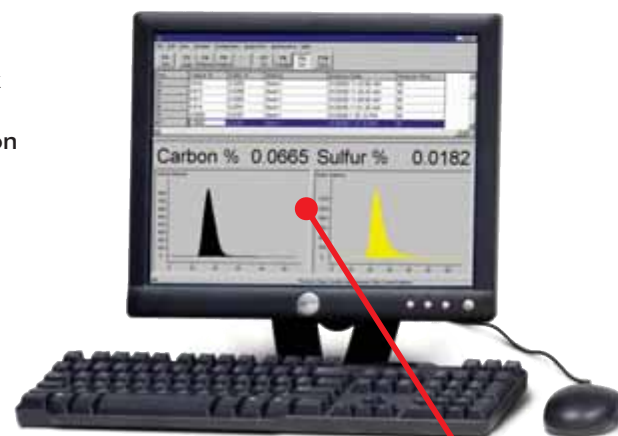

Windows® -Based Operating System
Maximizes flexibility for all operation, security, and diagnostic modes



Shuttle Autoloader
Optional 60-position carousel with integrated crucible load/unload